



MERCURY DISPLACEMENT INDUSTRIES, INC.

Post Office Box 710 - U.S. 12 East - Edwardsburg, Michigan 49112-0710

Phone (269) 663-8574 - Fax (269) 663-2924

(800) 634-4077



INDUSTRIAL CONTROL EQUIPMENT

235NC-24D-18

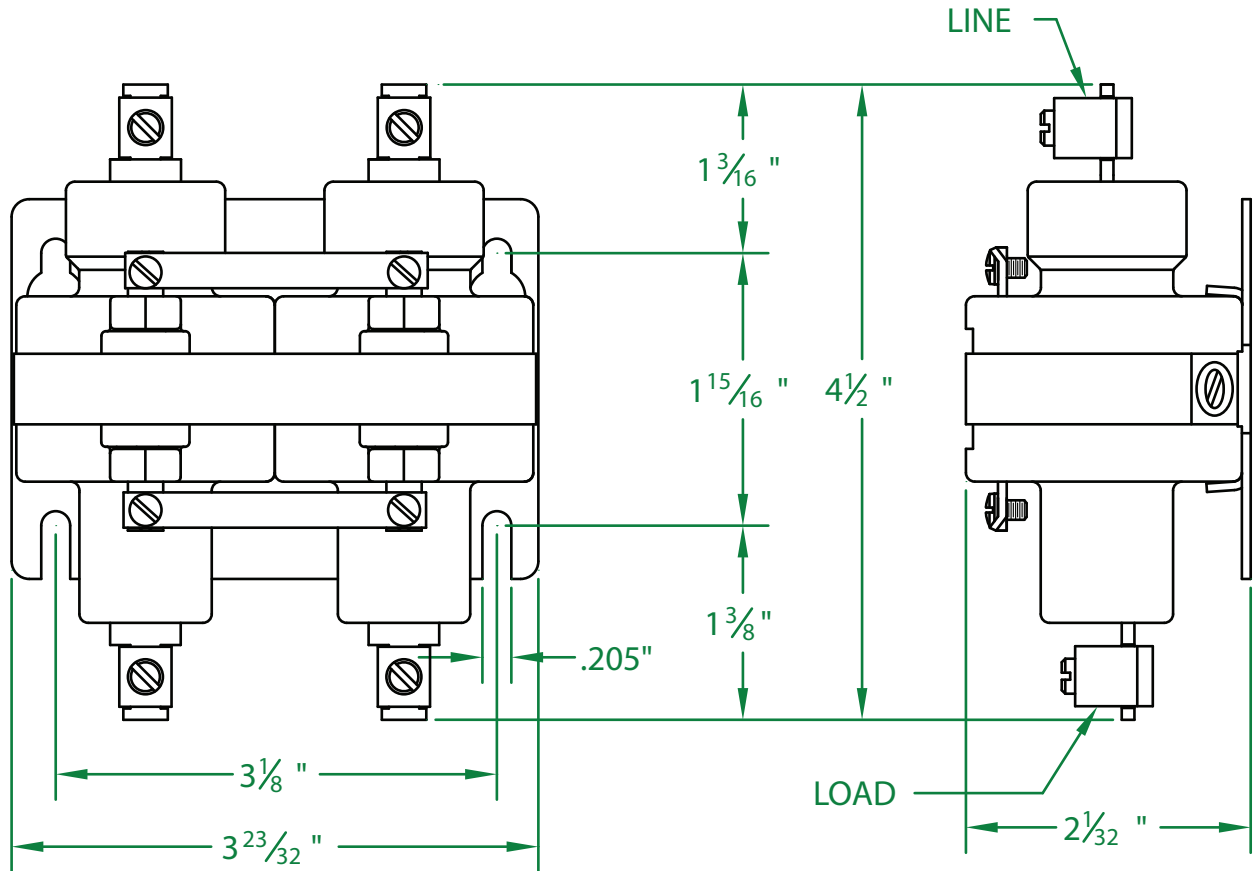

- * CONTACT RESISTANCE .003 ohms
- * DIELECTRIC WITHSTAND 2,500 VAC RMS
- * OPERATE TIME 30 MILLISECONDS
- * RELEASE TIME 35 MILLISECONDS
- * RATINGS:
 CONTACTS: 35 AMP @ 480 VAC
 RESISTIVE OR GENERAL PURPOSE
 COIL: 24 V.D.C.
 RESISTANCE: 88 Ω
 CURRENT: 272 mA
 VA: 6.6 WATTAGE: 6.6
- * TEMPERATURE RANGE -35° TO +85° C
- * COIL TERMINALS #6 BINDING HEAD SCREWS
 TORQUE TO 7 IN-LB
- * LOAD TERMINALS 4-14 AWG COMPRESSION TYPE
 TORQUE TO 31.5 IN-LB
- * TWO POLE / SINGLE THROW
- * STEEL STRAP (-18)
- * MAGNETICALLY ACTIVATED
- * MERCURY CONTACTOR
- * LIFE CYCLE ENDURANCE TESTS: U.L. 508 @ 100,00 & CSA 22.2 @ 250,000 CYCLES

Contactors - Relays - Switches