



# MERCURY DISPLACEMENT INDUSTRIES, INC.

Post Office Box 710 - U.S. 12 East - Edwardsburg, Michigan 49112-0710

Phone (269) 663-8574 - Fax (269) 663-2924

(800) 634-4077

## VSC-360R2R18U-01

### NORMALLY CLOSED (PUMP UP)

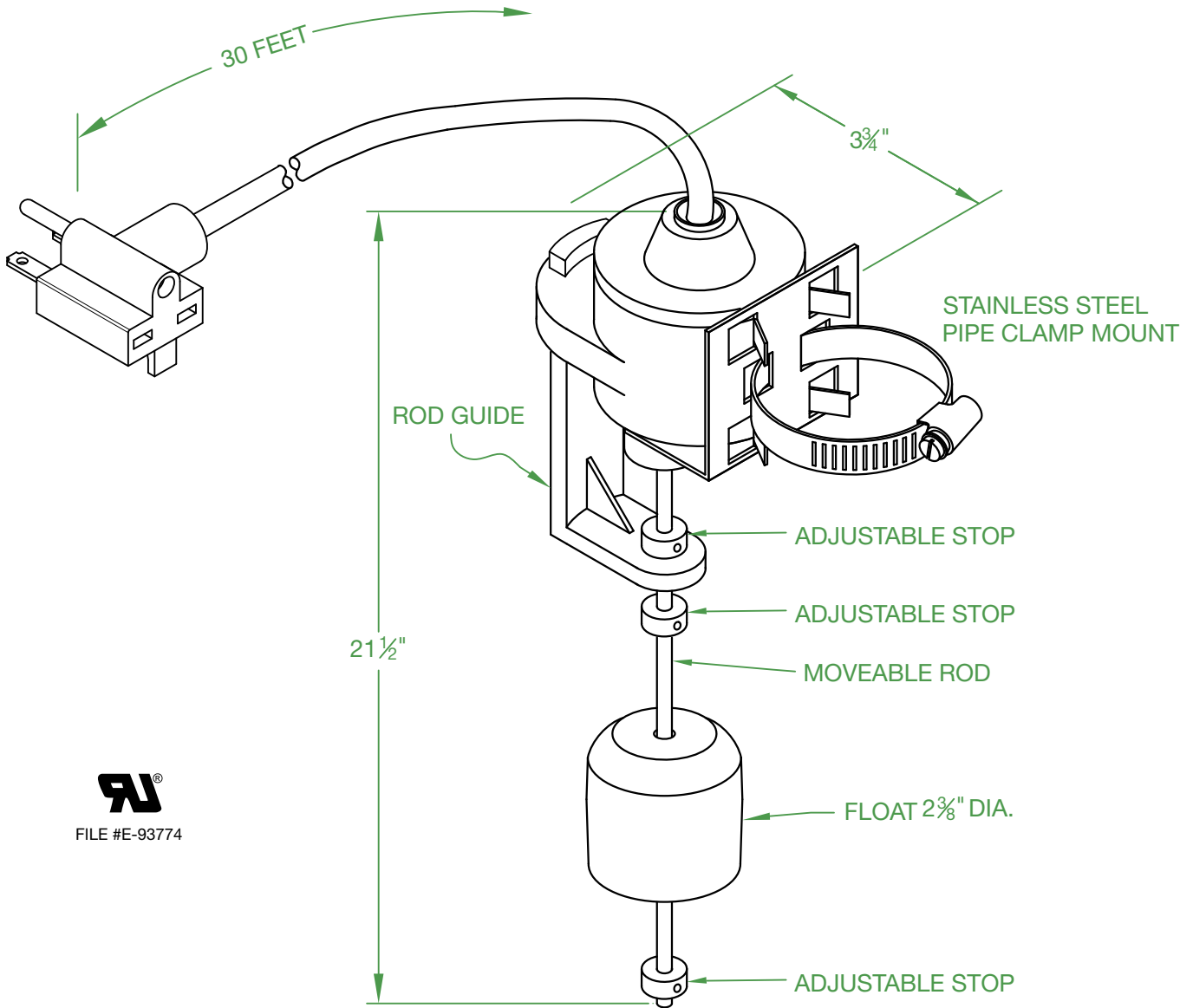

FILE #E-93774

#### RATINGS

1/2 H.P. @ 240V 50/60 Hz  
13 AMPS @ 240V 50/60 Hz

#### MATERIAL

ABS HOUSING AND GUIDE  
FIBERGLASS ROD  
POLYPROPELENE FLOAT  
STAINLESS STEEL ROD STOPS  
16-2 SJTOW/SJOW CORD

#### TEMPERATURE

140°F / 60°C

#### PUMPING RANGE

1" - 15"

March 19, 2020

## J.J.S.

Contactors - Relays - Switches

<http://www.mdius.com>