



MERCURY DISPLACEMENT INDUSTRIES, INC.

Post Office Box 710 - U.S. 12 East - Edwardsburg, Michigan 49112-0710

Phone (269) 663-8574 - Fax (269) 663-2924

(800) 634-4077

VSC-360R1R18U-01

NORMALLY CLOSED (PUMP UP)

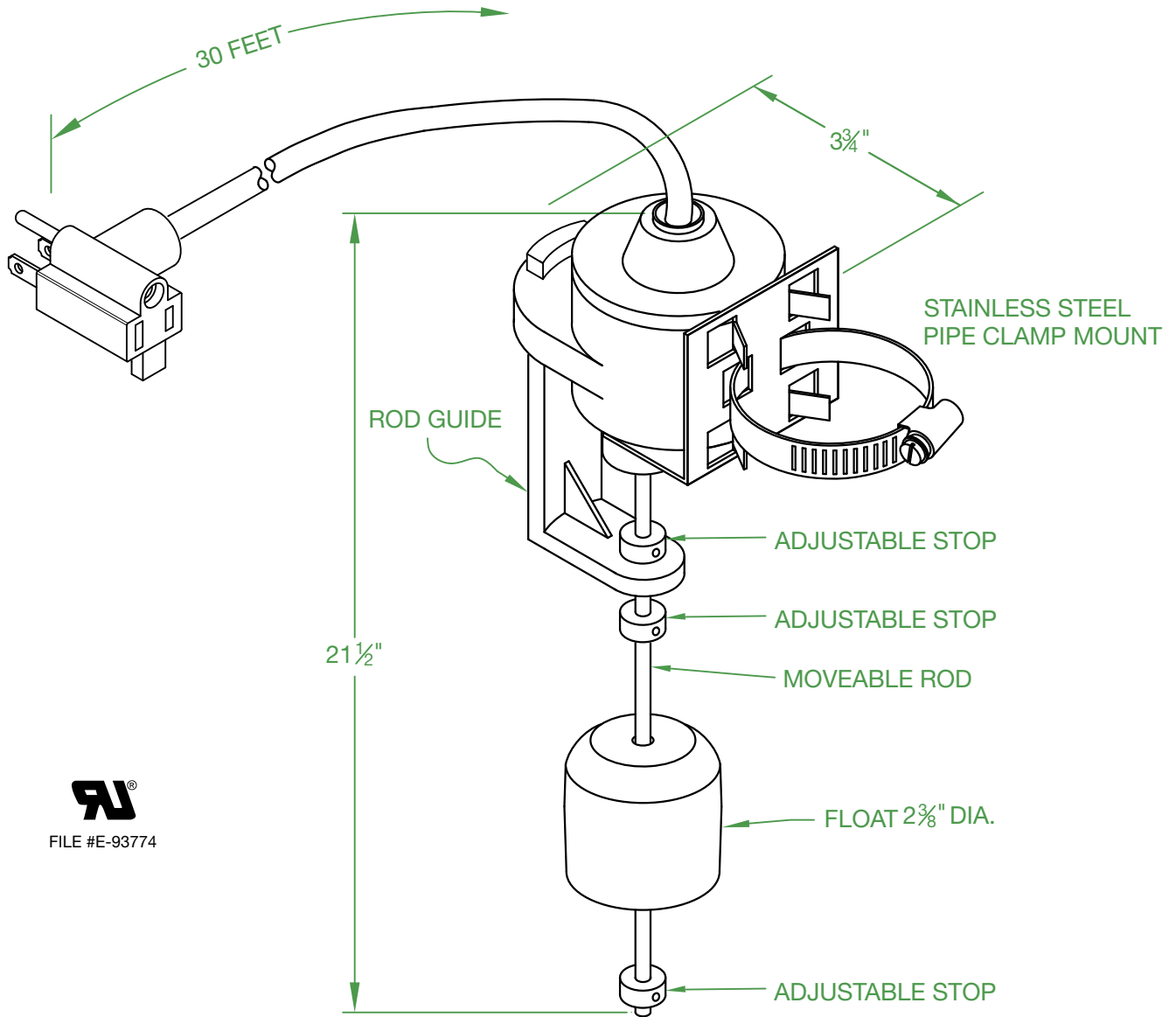

FILE #E-93774

RATINGS

1/2 H.P. @ 120V 50/60 Hz
13 AMPS @ 120V 50/60 Hz

MATERIAL

ABS HOUSING AND GUIDE
FIBERGLASS ROD
POLYPROPELENE FLOAT
STAINLESS STEEL ROD STOPS
16-2 SJTOW/SJOW CORD

TEMPERATURE

140°F / 60°C

PUMPING RANGE

1" - 15"

March 19, 2020

J.J.S.

Contactors - Relays - Switches

<http://www.mdius.com>