



# MERCURY DISPLACEMENT INDUSTRIES, INC.

Post Office Box 710 - U.S. 12 East - Edwardsburg, Michigan 49112-0710

Phone (269) 663-8574 - Fax (269) 663-2924

(800) 634-4077

## VS-360R2R9L-01

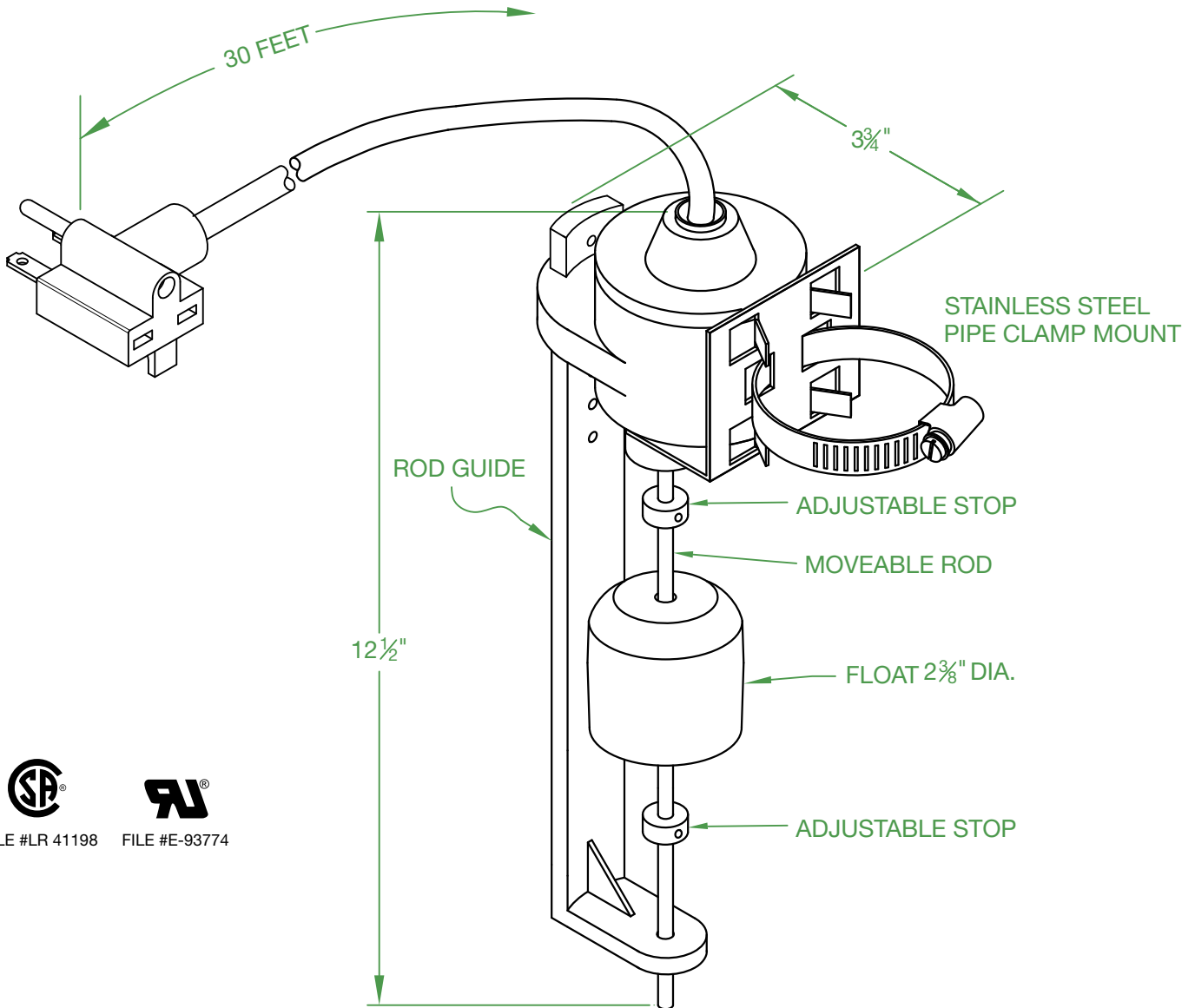

FILE #LR 41198



FILE #E-93774

### RATINGS

1/2 H.P. @ 120/240V 50/60 Hz  
13 AMPS @ 120/240V 50/60 Hz  
NORMALLY OPEN

### MATERIAL

ABS HOUSING AND GUIDE  
FIBERGLASS ROD  
POLYPROPELENE FLOAT  
STAINLESS STEEL ROD STOPS  
16-2 SJTOW/SJOW CORD

### TEMPERATURE

140°F / 60°C

### PUMPING RANGE

1" - 6"

September 12, 2017  
Rev A. 04-19-18

## J.J.S.

Contactors - Relays - Switches

<http://www.mdius.com>