



# MERCURY DISPLACEMENT INDUSTRIES, INC.

Post Office Box 710 - U.S. 12 East - Edwardsburg, Michigan 49112-0710

Phone (269) 663-8574 - Fax (269) 663-2924

(800) 634-4077

## NF2OW4000 MECHANICAL SWITCH

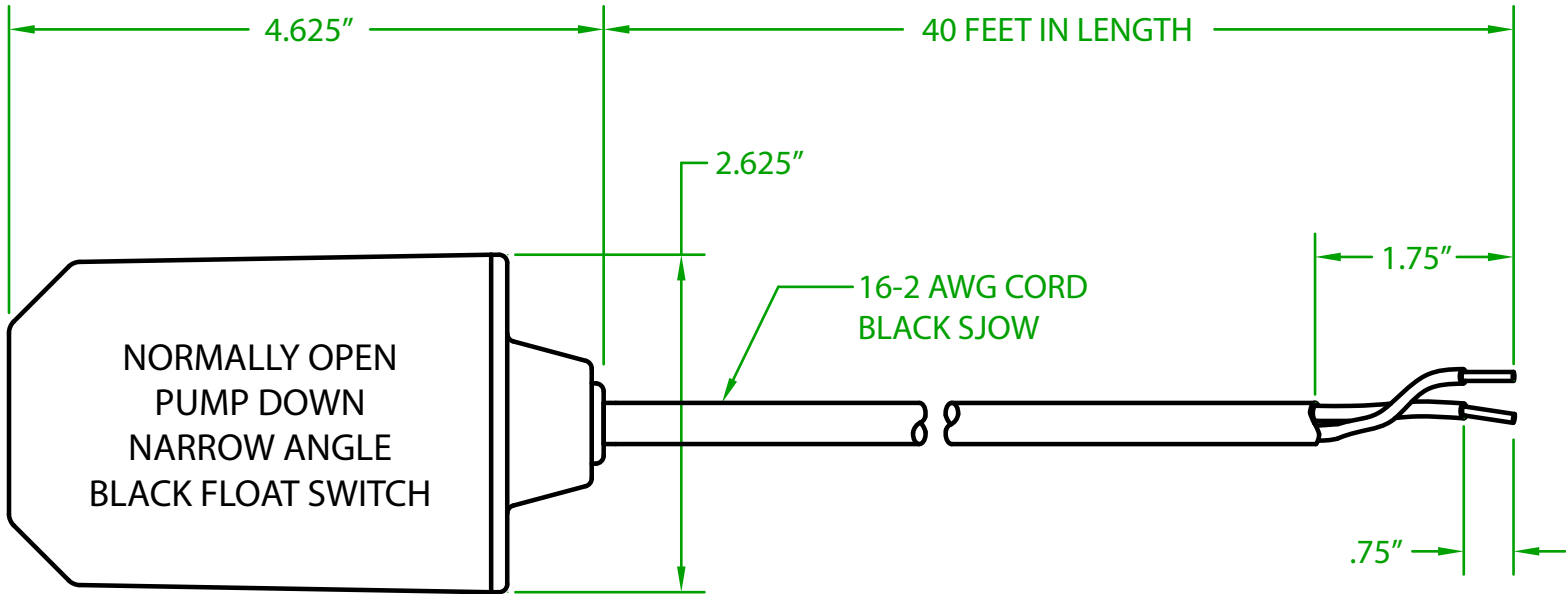

OPERATING ANGLE: CONTACTS CLOSED @ 25° ABOVE HORIZONTAL  
CONTACTS OPEN @ 10° BELOW HORIZONTAL

ELECTRICAL RATINGS: 1/4 H.P. @ 120/240 VAC  
10 AMPS @ 120/240 VAC 34.8 LRA

FLOAT MATERIAL: A.B.S.



J.J.S. April 23, 2020

Contactors - Relays - Switches

<http://www.mdious.com>